

Revision Notes.

1. UPDATED THE TEMPLATE AND ADDED UPDATE ASSEMBLY REF.

Checked By: DK

Approved By: SM

Date Released: 31/10/12

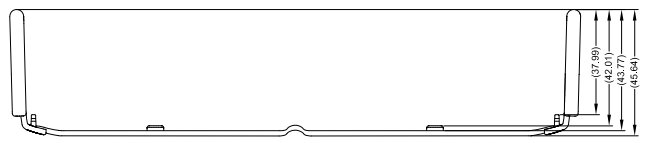
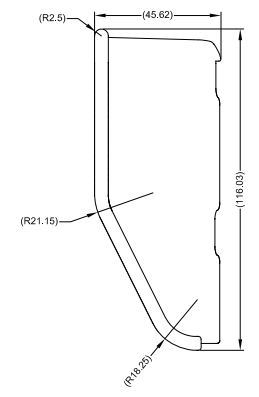
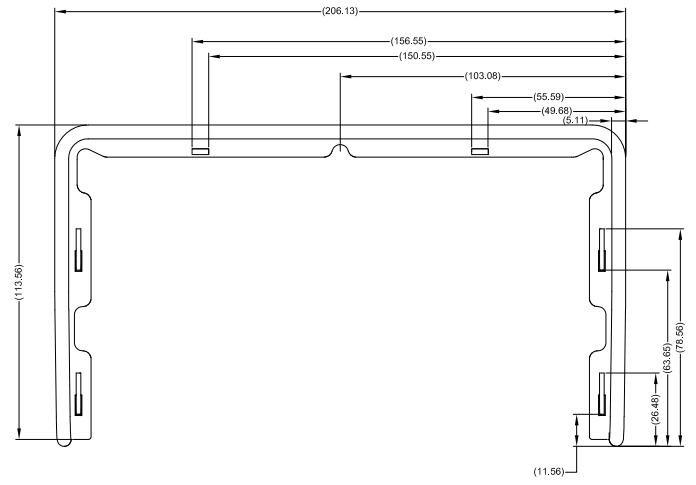
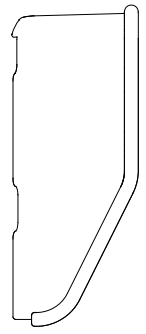
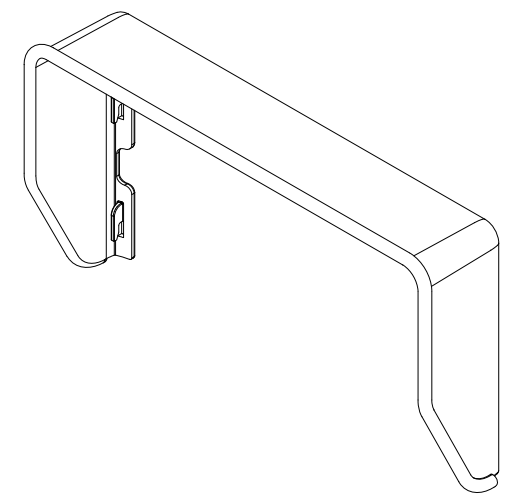
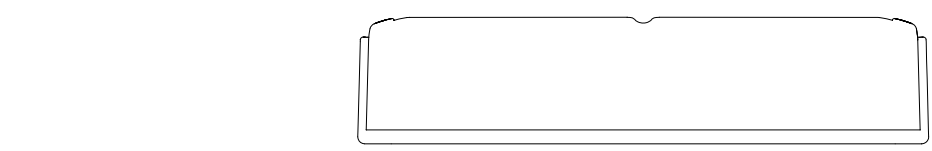

NOTES:
 1. MATERIAL:ABS.
 2. FINISH:SMOOTH, DARK GREY SPRAY.

PROPRIETARY NOTICE
 THIS DESIGN AND TECHNICAL INFORMATION APPEARING ON THIS DRAWING IS THE PROPERTY OF BRIGADE ELECTRONICS, AND IS DISCLOSED IN CONFIDENCE. IT IS NOT TO BE COPIED, REPRODUCED, REVEALED TO OR EXPROPRIATED BY OTHERS, EITHER IN WHOLE OR IN PART WITHOUT THE EXPRESS WRITTEN CONSENT OF BRIGADE ELECTRONICS.

BRIGADE[®]
 www.brigade-electronics.com

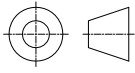
Assembly Pl Approval TROY CHOI (31/10/12)	Approved by D.KERAL	Checked by J.NEWMAN	Drawn by M.BUTLER
Angle of Projection 	Units mm	Scale N/A	Released 17/08/10
	Status RELEASED	Assembly Ref BE-970WM-SS	
	Stock Code 3430	BE-001199-01-10	